



**Thank you for owning an outboard motor.**

**Thank you for your trust in our company and products.**

- The outboard motors are powerful, economic and safe, manufactured with advanced technology.
- Please read this manual carefully before operating your outboard motor. A thorough understanding of the manual will help you to know this product for proper operation, maintenance and care. This will ensure that your outboard motor operates well under all conditions.
- We seek continuous improvement in product quality. Therefore, while this manual contains the most current product information available at the time of printing, there may be minor discrepancies between your machine and this manual. If there is any question concerning the manual, please consult your local PARSUN dealer.
- Data, illustrations or explanations in this Owner's Manual do not constitute base for any legal claim against our company.

**SUZHOU PARSUN POWER MACHINE CO., LTD.**



## Engine serial number

The engine serial number is carved on the aluminum casting of engine.



Engine serial number as follows:

--	--	--

--

--	--

--	--	--	--	--

## Table of contents

1. Main components and General information .....	1
1.1 Main components .....	1
1.2 General information .....	5
1.2.1 Specification .....	5
1.2.2 Fueling instruction .....	6
1.2.3 Propeller selection .....	7
2. Operation.....	8
2.1 Installation .....	8
2.1.1 Mounting height.....	9
2.1.2 Clamping the outboard motor .....	10
2.2 Breaking in engine.....	11
2.3 Pre-operation checks .....	12
2.4 Filling fuel .....	14
2.5 Starting engine .....	14
2.6 Warm up engine .....	20
2.7 Shifting .....	21
2.7.1 Forward .....	21
2.7.2 Reverse .....	22
2.8 Tiller.....	23
2.9 Stopping engine.....	25
2.10 Trimming outboard motor .....	27

2.11 Tilting up & down .....	28
2.11.1 Tilting up .....	28
2.11.2 Tilting down.....	30
2.12 Cruising in other conditions .....	31
2.12.1 Cruising in shallow water.....	31
2.12.2 Cruising in salt water .....	31
3. Maintenance.....	31
3.1 Greasing.....	32
3.2 Cleaning and adjusting spark plug .....	33
3.3 Checking the fuel system .....	34
3.3.1 Cleaning the fuel filter.....	35
3.4 Inspecting idling speed.....	36
3.5 Checking wiring and connectors.....	37
3.6 Checking for leakage.....	37
3.7 Checking propeller .....	37
3.7.1 Removing the propeller .....	39
3.7.2 Installing the propeller .....	39
3.8 Changing gear oil .....	40
3.9 Cleaning fuel tank.....	41
3.10 Checking and replacing anode(s).....	42
3.11 Checking top cowling.....	42
3.12 Maintenance Table .....	43
4 Transporting and storing.....	46

4.1 Transporting .....	46
4.2 Storing .....	46
5. Actions in emergency .....	48
5.1 Impact damage.....	48
5.2 Power trim and tilt unit will not operate .....	49
5.3 Starter will not operate.....	50
5.5 Treatment of submerged motor .....	52
6. Troubleshooting.....	53
7. Circuit diagram .....	57

# 1. Main components and General information

## 1.1 Main components

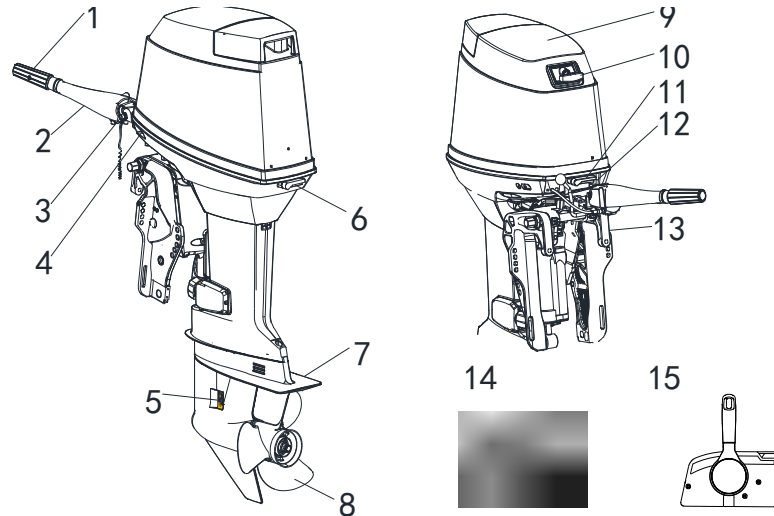

1. Throttle grip

2. Tiller handle

3. Engine stop button and switch

4. Fuel connector

5. Cooling water inlet

6. Top cowling lock handle

7. Anti-cavitation plate

8. Propeller

9. Top cowling

10. Starters handle

11. Top cowling lock handle

12. Choke handle

13. Clamp bracket

14. Portable fuel tank

15. Remote control box



**A portable fuel tank includes parts as follows:**

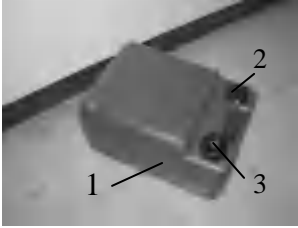

1. Fuel tank cap
2. Fuel joint

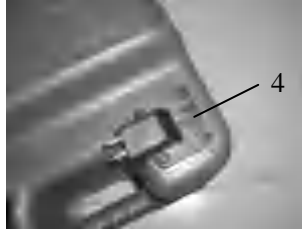

3. Air vent screw
4. Fuel gauge



**WARNING:**

**The fuel tank supplier with this engine could only be used as supply of fuel for its running and must not be as a fuel storage container.**

**Remote control box**

The remote control lever actuates both the shifter and the throttle. The electrical switches are mounted on the remote control box.

1. Remoter control lever
2. Neutral interlock trigger
3. Neutral throttle lever
4. Main switch/choke switch
5. Engine stop switch
6. Throttle friction adjuster

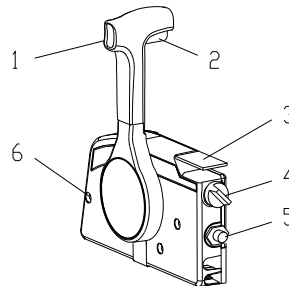

## Remote control lever

Moving the lever forward from the neutral position engages forward gear. Pulling the lever back from neutral engages reverse. The engine will continue to run at idle until the lever is moved about 35° (a detent can be felt). Moving the lever farther opens the throttle, and the engine will begin to accelerate.

1. Neutral "N"
2. Forward "F"
3. Reverse "R"
4. Shift
5. Fully closed
6. Throttle
7. Fully open

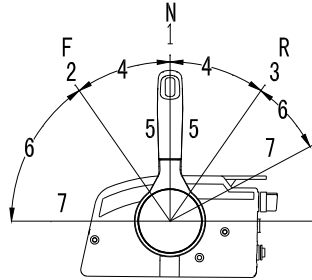

## Neutral interlock trigger

To shift out of neutral, first pull the neutral interlock trigger up.

1. Neutral interlock trigger

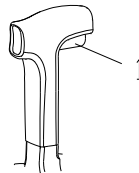

### Neutral throttle lever

To open the throttle without shifting into either forward or reverse, put the remote control lever in the neutral position and lift the neutral throttle lever.

#### NOTE:

**The neutral throttle lever will operate only when the remote control lever is in neutral.**

**The remote control lever will operate only when the neutral throttle lever is in the closed position.**

1. Fully open
2. Fully closed

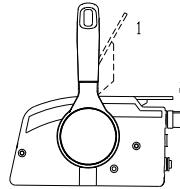

## 1.2 General information

### 1.2.1 Specification

#### Main technical data:

Items	Data	Items	Data
Type of engine	Three cylinders,2-stroke	Fuel tank capacity	24L
Displacement	849cm <sup>3</sup>	Gear oil quantity	610cm <sup>3</sup>
Bore X stroke	72.0mm×69.5mm	Spark plug	NGK BR7HS
Gear ratio	2.08 (27/13)	Overall width	364mm
Weight T60ABML/T50BML	105Kg	Overall height	BML/BWL 1530mm
Weight T60ABWL/T50BWL	106.5kg		FWL 1479mm
Weight T60AFWL/T50FWL	107Kg	Transom height	BML/BWL 559mm
Recommended engine oil	2-stroke engine oil		FWL 508mm
Recommended fuel	Unleaded regular gasoline	Overall length	1197mm(BM/BW)
Recommended gear oil	Hypoid gear oil SAE # 90	Overall length	713mm(FW)

#### Main performance:

Items	Data	Items	Data
Maximum output	60HP	Tightening torque for engine	Spark plug
	50HP		Propeller nut
Idling speed (in neutral)	1000±50rpm		
Full throttle operating range	4500~5500rpm		
			25.0Nm
			34.0Nm

## 2.2 Fueling instruction

### Fueling instructions:

Recommended gasoline:  
Regular unleaded gasoline, If it is not available, then premium gasoline.

If knocking or pinging occurs, use a different brand of gasoline or premium unleaded fuel.

#### **WARNING:**

- **Do not smoke when refueling, and keep away from sparks, flames, or other sources of ignition.**
- **Stop engine before refueling.**
- **Refuel in a well-ventilated area; refuel portable fuel tanks off the boat.**
- **Do not overfill the fuel tank.**
- **Take care not to spill gasoline, if gasoline spills, wipe it up immediately.**
- **Tighten the filler cap securely after refueling.**
- **If you should swallow some gasoline, inhale a lot of gasoline vapor, or get gasoline in your eye, get immediate medical attentions.**
- **If any gasoline spills onto your skin, immediately wash with soap and water. Change clothing if gasoline spills on it.**
- **Touch the fuel nozzle to metal components to prevent electrostatic sparks.**

#### **CAUTION:**

**Use only new clean gasoline which has been stored in clean containers and is not contaminated with water or foreign matter.**

**Engine oil:**

Recommended engine oil: 2-stroke outboard motor oil.

Gasoline and oil mixing:

Break-in period		25:1			
	Gasoline	1L	12L	14L	24L
	Engine oil	0.04L	0.48L	0.56L	0.96L
After break-in		50:1			
	Gasoline	1L	12L	14L	24L
	Engine oil	0.02L	0.24L	0.28L	0.48L

**CAUTION:**

**Be sure to mix gasoline and oil completely, otherwise the engine may be damaged.**

### 1.2.3 Propeller selection

The performance of your outboard motor will be critically affected by your choice of propeller, as an incorrect choice could adversely affect performance. The outboard motor is fitted with propellers chosen to perform well over a range of applications, but there may be uses where a propeller with a different pitch would be more appropriate. Dealers stock a range of propellers and can advise you and install a propeller on your out board that is best suited to your application.

For a greater boat load and a low engine speed, a smaller-pitch propeller is more suitable. Conversely, a large-pitch propeller is more suitable for a smaller operating load as it enables the correct engine speed to be maintained.

## 2. Operation

### 2.1 Installation

Mount the outboard motor on the center line (keel line) of the boat. For boats without a keel or which are asymmetrical, consult your dealers.

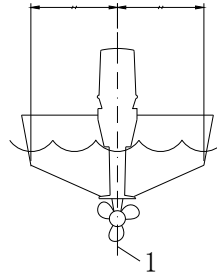

1. Center line (keel line)

#### NOTE:

During water testing check the buoyancy of the boat, at rest, with its maximum load. Check that the static water level on the exhaust housing is low enough to prevent water entry into the power head, when water rises due to waves when the outboard is not running.

#### WARNING:

- **Overpowering a boat could cause severe instability. Do not install an outboard motor with more horsepower than the maximum rating on the capacity plate of the boat. If the boat does not have a capacity plate, consult the boat manufacturer.**

- **Improper mounting of the outboard motor could result in hazardous conditions. Your dealer or other person experienced in proper rigging should mount the motor. If you are mounting the motor yourself, you should be trained by an experienced person.**
- **The information presented in this section is intended as reference only. Proper mounting depends in part on experience and the specific boat and motor combination.**

### 2.1.1 Mounting height

The mounting height of the outboard motor greatly affects your boat running efficiency. If the mounting height is too high, cavitation tends to occur, thus reducing the propulsion. If the mounting height is too low, the water resistance will increase and thereby reduce engine efficiency. Mount the outboard motor so that the anti-cavitation plate is between the bottom of the boat and a level 25mm below it.

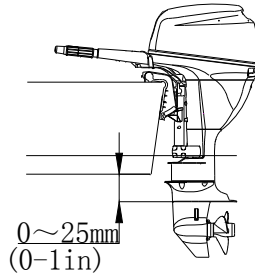



**NOTE:**

The optimum mounting height of the outboard motor is affected by the boat and motor combination and the desired use. Test runs at a different height can help determine the optimum mounting height. For further information, consult your “PARSUN” dealer or boat manufacturer.

## 2.1.2 Clamping the outboard motor

1. Tighten the transom clamp bolts evenly and securely. Occasionally check the clamp bolts for tightness during operation of the outboard motor because they could become loose due to engine vibration.

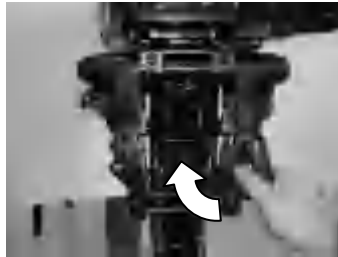

**CAUTION:**

Outboards that use clamp bracket screws alone are **INSUFFICIENT** to properly and safely secure the outboard to the Transom. Proper installation of the outboard includes bolting the engine to the boat through the transom.



**WARNING:**

Loose clamp screws could allow the outboard motor to fall off or move on the transom. This could cause loss of control. Make sure the clamp screws are tightened securely, occasionally

**check the screws for tightness during operation.**

2. If the engine restraint cable attachment is equipped on your engine, an engine restraint cable or chain should be used. Attach to a secure mounting point on the boat to avoid the engine being completely lost if it accidentally falls off the transom.



3. Secure the clamp bracket to the transom using the appropriate bolts. For details, consult your dealer.

**⚠ WARNING:**

**Always use the bolts, nuts and washers coming as accessories inside the engine package. If the engine package does not include such, or if you want to use different size bolts, nuts or washers, please consult your Parsun dealer and choose bolts, nuts and washers with appropriate materials and strength.**

## 2.2 Breaking in engine

Your new engine requires a period of breaking to allow mating surfaces of moving parts to wear in evenly.

Gasoline and oil mixing:

Break-in period	25:1				
	Gasoline	1L	12L	14L	24L
	Engine oil	0.04L	0.48L	0.56L	0.96L

## **CAUTION**

**Failure to follow the break-in procedure could result in reduced engine life or even severe engine Damage.**

1. for the first 10 minutes of operation.  
Run the engine at the idle speed.
2. for next 50 minutes of operation:  
Run the engine at 3000 r/min or at approximately half throttle.
3. for the next two hours of operation:  
Run the engine at 4000 r/min or at approximately three-quarter throttle.
4. for the next seven hours of operation:  
Avoid continuous operation at full throttle for more than five minutes at a time.
5. Operate the engine normally.

## **2.3 Pre-operation checks**

### **Fuel**

- Check to be sure you have plenty of fuel for your trip.
- Make sure there are no fuel leaks or gasoline fumes.
- Check fuel line connections to be sure they are tight.
- Be sure the fuel tank is positioned on a secure, flat surface, and that the fuel line is not twisted or flattened, or likely to contact sharp objects.

## **Controls**

- Check throttle, shift and steering for proper operation before starting the engine.
- The controls should work smoothly, without binding or unusual free play.
- Look for loose or damaged connections.
- Check operation of the starter and stop switches when the outboard motor is in the water.

## **Engine**

- Check the engine, top cowling and engine mounting.
- Look for loose or damaged fasteners.
- Check the propeller for damage.

### **WARNING:**

**If any item in the pre-operation check is not working properly, have it inspected and repaired before operating the outboard motor. Otherwise an accident could occur.**

### **CAUTION**

**·Do not start the engine out of water. Overheating and serious engine damage can occur.**

## 2.4 Filling fuel

### **WARNING:**

**Gasoline and its vapors are highly flammable and explosive. Keep away from sparks, cigarettes, flames, or other sources of ignition.**

1. Remove the fuel tank cap.

2. Carefully fill the fuel tank.



3. Securely close the cap after filling the tank. Wipe up any spilled fuel.

## 2.5 Starting engine

1. Connect fuel joints securely after loosening the air vent screw on the fuel tank cap (2 or 3 turns).



2. Connect fuel joints securely and squeeze the primer pump with the outlet end up until you feel it become firm (if equipped the fuel joint).



3. Place the gear shift lever in neutral.

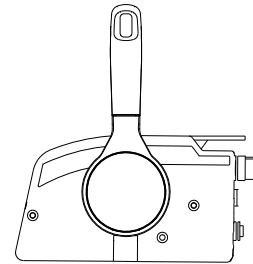

**NOTE:**

The start-in-gear protection device prevents the engine from starting except when in neutral. Attach the engine stop switch lanyard to secure place on your clothing, or your arm or leg. Then install the lock plate on the other end of the lanyard into the engine stop switch.

**⚠ WARNING:**

- The engine must be starting in neutral otherwise damage starter and hazard can occur.
- Do not attach the lanyard to clothing that could tear loose. Do not route the lanyard where it could become entangled and preventing it from functioning
- Avoid accidentally pulling the lanyard during normal operation. Loss of engine power means the loss of steering control. Also, without engine power, the boat could slow rapidly. This could cause people and objects in the boat to be thrown forward.



4.

For manual start model:

Place the throttle grip in the “**START**” position.



For Electric start model:

Turn the main switch to “**ON**” (Electric start).



For remote control model:

When the engine is in neutral position, open the throttle a little by turning the throttle handle, inching. You may need to adjust the position of the throttle according to the engine’s temperature. When the engine starts, return the throttle handle, inching to its original position.

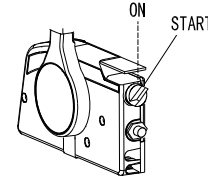



5.

For manual start model:

Pull out the choke handle fully

For electric start model:

Press the start switch to run the choke system. Release the switch and it will return to the original position.

Note: For BW model, there is a separate SWITCH BOX and it's installed close to the tiller handle.

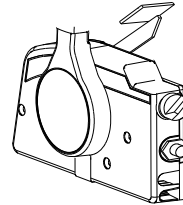

**NOTE:**

**It is not necessary to use the choke when starting a warm engine.**

**If the choke is left in the “START” (start) position while the engine is running, the engine will run poorly or stall.**

6. Pull the manual starter handle slowly until you feel resistance. Then give a strong pull straight to crank and start the engine. Repeat if necessary.

Turn the main switch to “**START**” (start), and hold it for a maximum of 5 seconds (Electric start).

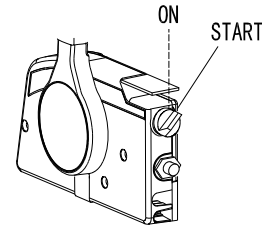
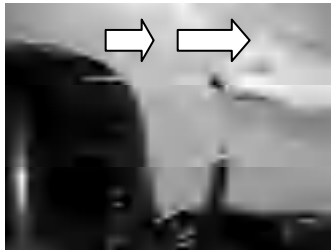

7. After the engine starts, slowly return the manual starter handle to its original position before releasing it.

Immediately release the main switch and allow it to return to “ON” (on) after the engine starts (Electric start).

8. Slowly return the throttle grip to the fully closed position.

### **CAUTION**

- When the engine is cold, it needs to be warmed up.
- If the engine does not start on the first try, repeat the procedure. If the engine fails to start after 4 or 5 tries:

**BM/BW Models:** open the throttle a small amount (between 1/8 and 1/4), and try again.

**FW models:** open the neutral throttle lever on the remote control box, and try again.

### **NOTE:**

**Never turn the main switch to “START” (start) while the engine is running.**

**Do not keep the starter motor turning for more than 5 seconds. If the starter motor is turned continuously for more than 5 seconds, the battery will be quickly discharged, thus making it impossible to start the engine. The starter can also be damaged. If the engine will not start after 5 seconds of cranking, return the main switch to “ON” (on), wait 10 seconds, and then crank the engine.**

## 2.6 Warm up engine

1. After starting the engine, place the gear shift lever in neutral. For approximately the first 3 minutes after starting, warm up the engine by operating at one fifth throttle or less. Otherwise, it will shorten engine life.

### NOTE:

**If the choke knob is left pulled out after the engine starts, the engine will stall.**

**In the temperatures of -5°C or less, leave the choke knob pulled out fully for approximately 30 seconds after starting.**

2. Check for steady flow of water from the cooling water pilot hole.



### CAUTION:

- If water is not flowing out of the hole at all times while the engine is running, stop the engine and check whether the cooling water inlet on the lower case or the cooling water pilot hole is blocked.
- If the problem cannot be located and corrected, consult your dealer.

## 2.7 Shifting

### **WARNING:**

Before shifting, make sure there are no swimmers or obstacles in the water near you.

### **CAUTION:**

To shift from forward to reverse or vice versa, first close the throttle so that the engine idles (or runs at low speeds).

### 2.7.1 Forward

1. Place the throttle grip in the fully closed position.

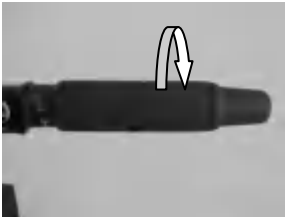

2. Move the gear shift lever quickly and firmly from neutral to forward.  
Pull up the neutral interlock rigger and move the remote control lever quickly and firmly from neutral to forward. (Remote control)

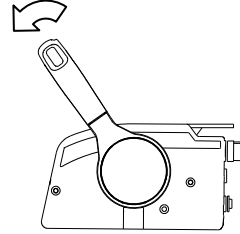

## 2.7.2 Reverse

### **WARNING:**

**When operating in reverse, go slowly. Do not open the throttle more than half. Otherwise the boat could become unstable, which could result in loss of control and an accident.**

1. Place the throttle trip in the fully closed position.

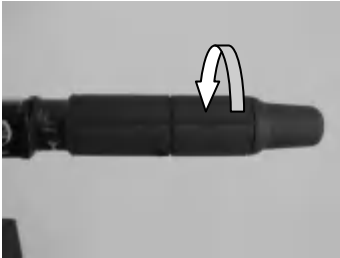

2. Move the gear shift lever quickly and firmly from neutral to reverse.

Check that the tilt lock lever is in the lock position. Pull up the neutral interlock rigger and move the remote control lever quickly and firmly from neutral to reverse. (Remote control)

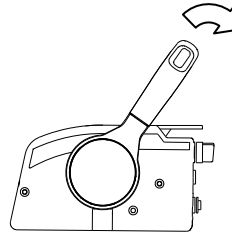

## 2.8 Tiller

### 1. Change direction

To change direction, move the tiller handle to the left or right as necessary.

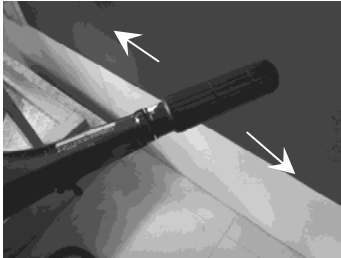

## 2. Change speed

Turn the grip counterclockwise to increase speed and clockwise to decrease speed.

## 3. Throttle indicator

The throttle indicator is on the throttle grip. The fuel consumption curve on the throttle indicator shows the relative amount of fuel consumed for each throttle position. Choose the setting that offers the best performance and fuel economy for the desired operation.

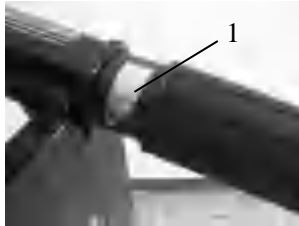

1. Throttle indicator

## 4. Throttle friction adjuster

The throttle friction adjuster is on the tiller handle, which provides adjustable resistance to movement of the throttle grip, and can be set according to operator preference. To increase resistance, turn the adjuster clockwise. To decrease resistance, turn the adjuster counterclockwise. When constant speed is desired, tighten the adjuster to maintain the desired throttle setting.

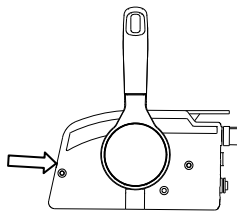

**⚠ WARNING:**

**Do not over-tighten the friction adjuster. If there is too much resistance, it could be difficult to move throttle lever or grip, which could result in an accident.**

## 2.9 Stopping engine

**NOTE:**

**Before stopping the engine, first let it cool off for a few minutes at idle or low speed. Stopping the engine immediately after operating at high speed is not recommended.**

1. Push and hold the engine stop button until the engine comes to a complete stop.

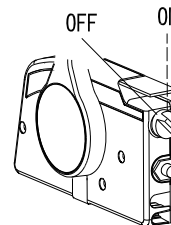



**NOTE:**

**If the outboard motor is equipped with an engine stop switch lanyard, the engine can also be stopped by pulling the lanyard and removing the lock plate from the engine stop switch.**

2. Tighten the air vent screw on the fuel tank cap.



3. After stopping the engine, disconnect the fuel line if there is a fuel joint on the outboard motor.



## 2.10 Trimming outboard motor

There are 4 or 5 holes provided in the clamp bracket to adjust the outboard motor trim angle.

1. Stop the engine.
2. Remove the trim rod from the clamp bracket while slightly tilting the outboard motor up.



3. Reposition the rod in the desired hole. Make test runs with the trim set to different angles to find the position that works best for your boat and operating conditions.

**⚠ WARNING:**

- **Stop the engine before adjusting the trim angle.**
- **Use care to avoid being pinched when removing or installing the rod.**
- **Use caution when trying a trim position for the first time. Increase speed gradually and watch for any signs of instability or control problems. Improper trim angle can cause loss of control.**

## 2.11 Tilting up & down

If the engine will be stopped for some time or if the boat is moored in shallows, the outboard motor should be tilted up to protect the propeller and casing from damaged by collision with obstructions, and also to reduce corrosion.

### **WARNING**

#### **WARNING:**

**Be sure all people are clear of the outboard motor when tilting up and down, also be careful not to pinch any body parts between the drive unit and engine bracket.**

#### **NOTE:**

**Do not tilt up the engine by pushing the tiller handle because this could break the handle. The outboard motor cannot be tilted when in reverse.**

### 2.11.1 Tilting up

1. Place the gear shift lever in neutral and outboard turn towards the rigging ahead.



2. Disc...

outboard motor.

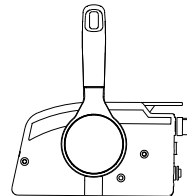



3. Place the tilt lock lever (if equipped) in the up position.



4. Hold the rear of the top cowling and tilt the engine up fully until the tilt support lever automatically locks.

5. Place the tilt lock lever in the down position.

For electric tilt model:

Press the “UP” switch to tilt the outboard motor up to the highest position

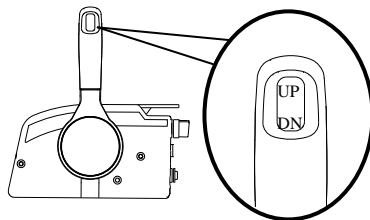

### 2.11.2 Tilting down

1. Slightly tilt the outboard motor up.
2. Pull out the tilt support lever, pull up the tilt lock lever, and slowly tilt the outboard motor down.
3. Pull down the tilt lock lever when outboard moves down to the lowest position. (For manual tilt model)

For electric tilt model:

Pull out the tilt support lever, press the “DN” switch to tilt the outboard motor down to the lowest position.

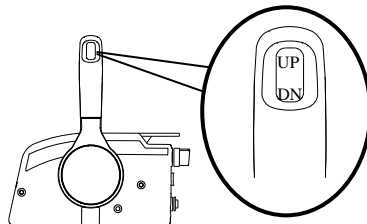

#### **WARNING:**

**Make sure the tilt & trim unit is in locked position when running the outboard (For manual tilt model).**

## 2.12 Cruising in other conditions

### 2.12.1 Cruising in shallow water

The outboard motor can be tilted up partially to allow operation in shallow water.

#### **WARNING:**

- **Be sure to place the gear shift in neutral before cruising in shallow water or while tilting up the outboard motor.**
- **Return the outboard motor to its normal position as soon as the boat is back in deeper water.**

#### **CAUTION:**

**The cooling water inlet on the lower unit should be not above the surface of the water when setting up for and cruising in shallow water. Otherwise severe damage from overheating can result. For tilting procedure, see section 2.11.**

### 2.12.2 Cruising in salt water

After operating in salt water, wash out the cooling water passages with fresh water to prevent them from becoming clogged with salt deposits.

## 3. Maintenance

While using the outboard motor, the periodic maintenance is necessary for you to ensure its performance.

**⚠WARNING:**

- **Be sure to turn off the engine when you perform maintenance unless otherwise specified.**
- **If you or the owner is not familiar with machine servicing, this work should be done by your dealer or other qualified mechanic.**

**CAUTION:**

**If replacement parts are necessary, use only original parts or parts of the same type and of equivalent strength and materials.**

### **3.1 Greasing**

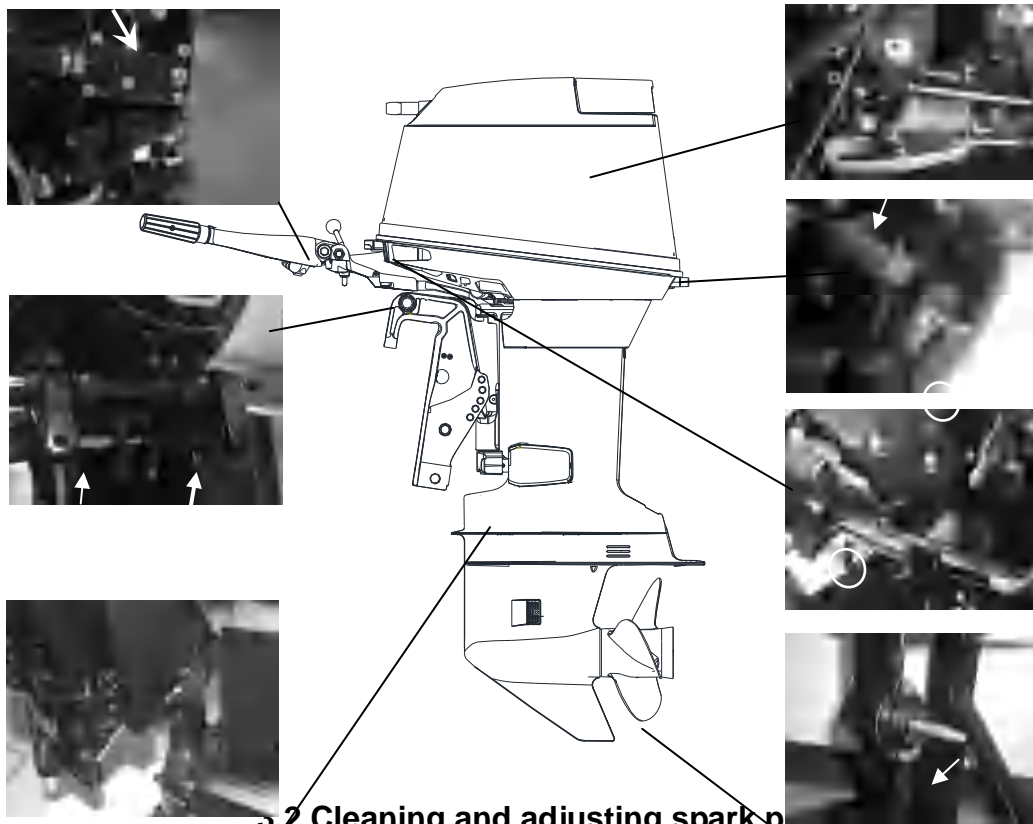

### 5.2 Cleaning and adjusting spark plug

You should periodically remove and inspect the spark plug because heat and deposits will cause the spark plug to slowly break down and erode. If necessary, you should replace the spark plug with



another of the correct type.

Before fitting the spark plug, measure the electrode gap with a wire thickness gauge; adjust the gap to specification if necessary.

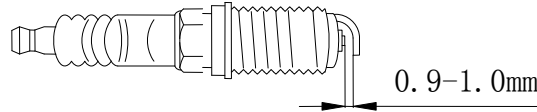

When fitting the plug, always clean the gasket surface and use a new gasket. Wipe off any dirt from the threads and screw in the spark plug to the correct torque.

### 3.3 Checking the fuel system

1. Check the fuel lines for leaks, crack, or malfunction. If a problem is found, your dealer or other qualified mechanic should repair it immediately.



#### **⚠ WARNING:**

- Check for fuel leakage regularly.
- If any fuel leakage is found, the fuel system must be repaired by a qualified mechanic.

2. Check the fuel filter periodically. If foreign matter is found in the filter, clean it.



### 3.3.1 Cleaning the fuel filter

1. Remove the nut holding the fuel filter assembly if equipped.



2. Unscrew the filter cup, catching any spilled fuel in a rag.

3. Remove the filter element, and wash it in solvent. Allow it to dry. Inspect the filter element and O-ring of the filter cup to make sure they are in good conditions. Change them if necessary. If any water is found in the fuel, check and clean the portable fuel tanks should be checked and cleaned.



1. Filter cup    2.O-ring    3. Filter element    4.Filter housing    5. Filter seat

4. Reinstall the filter element in the cup. Make sure the O-ring is in position in the cup. Firmly screw the cup onto the filter housing.

5. Attach the filter assembly to the bracket so that the fuel hoses are attached to the filter assembly. Run the engine and check the filter and lines for leaks.

### 3.4 Inspecting idling speed

A diagnostic tachometer should be used for this procedure. Results may vary depending on whether testing is conducted with the flushing attachment, in a test water tank, or with the outboard motor in the water.

1. Start the engine and allow it to warm up fully in neutral until it is running smoothly.

2. Verify whether the idle speed is set to specification.

Engine idle speed:  $1000 \pm 50$ rpm.

**CAUTION:**

Correct idling speed inspection is only possible if the engine is fully warmed up. If not warmed up fully, the idle speed will measure higher than normal. If you have difficulty verifying the idle speed, or the idle speed requires adjustment, consult your dealer or other qualified mechanic.

### 3.5 Checking wiring and connectors

Check that each grounding wire is properly secured and each connector is engaged securely.

### 3.6 Checking for leakage

Check that no exhaust or water leaks from the joints between the exhaust cover, cylinder head and body cylinder. Check for oil leaks on the around the engine.

**CAUTION:**

If any leaks are found, consult your dealer.

### 3.7 Checking propeller

**WARNING:**

Before inspecting, removing or installing the propeller, always take actions to ensure the

engine will not accidentally starts, such as removing the spark plug caps from the spark plugs, placing the shift control in neutral, and removing the lanyard from the engine stop switch, etc. Serious accident could occur if the engine starts when you are nearby.

Do not use your hand to hold the propeller when loosening or tightening the propeller nut. Put a wood block between the anti-cavitation plate and the propeller to prevent the propeller from turning.



1. Check each of the propeller blades for wear, erosion from cavitation or ventilation, or other damage.
2. Check the propeller shaft for damage.
3. Check the splines' shear pin for wear or damage.
4. Check for fish line tangled around the propeller shaft.
5. Check for the propeller shaft oil seal for damage.

### 3.7.1 Removing the propeller

1. Straighten the cotter pin and pull it out using a pair of pliers.
2. Remove the propeller nut, washer, and spacer (if equipped).
3. Remove the propeller and thrust washer.



1. Cotter pin 2. Nut 3. Washer 4. Propeller 5. Thrust washer

### 3.7.2 Installing the propeller

#### **CAUTION:**

**Be sure to install the thrust washer before installing the propeller, otherwise the lower case and propeller boss could be damaged.**

**Be sure to use a new cotter pin and bend the ends over securely. Otherwise the propeller could come off during operation and be lost.**

1. Apply a marine grease or corrosion resistant grease to the propeller shaft.
2. Install the spacer (if equipped), thrust washer, and propeller on the propeller shaft.
3. Install the spacer (if equipped) and the washer.
4. Tighten the propeller nut. Align the propeller nut with the propeller shaft hole. Insert a new cotter pin in the hole and bend the cotter pin ends.

## 3.8 Changing gear oil

### **⚠ WARNING:**

**Be sure the outboard motor is securely fastened to the transom or a stable stand. Never get under the lower unit while the outboard motor is tilted, even when the tilt support lever or knob is locked. Serious injury could occur if the motor falls.**

1. Tilt the outboard motor so that the gear oil drain screw is at the lowest point possible.
2. Place a suitable container under the gear case.
3. Remove gear oil drain screw.

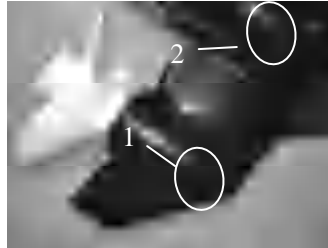

1. Gear oil drain screw
2. Oil level plug

### **CAUTION:**

**Change the gear oil after the first 10 hours of operation, and every 100 hours or at 6-month intervals thereafter. Otherwise the gear will wear quickly.**

4. Remove the oil level plug to allow the oil to drain completely.

**CAUTION:**

**Inspect the used oil after it has been drained. If the oil is milky, water is getting into the gear case which can cause gear damage. Consult your dealer.**

5. Use a flexible or pressurized filling device; inject the gear oil into the gear oil drain screw hole.  
(430cm<sup>3</sup>)

6. When the oil begins to flow out of the oil level plug hole, insert and tighten the oil level plug (If necessary, change the seal gasket).

7. Insert and tighten the gear oil drain screw (If necessary, change the seal gasket).

### 3.9 Cleaning fuel tank



**WARNING:**

- **Keep away from sparks, cigarettes, flames, or other sources of ignition when cleaning the fuel tank.**
- **Cleaning the fuel tank in a well-ventilated open air.**

1. Empty the fuel tank into an approved container.

2. Pour a small amount of suitable solvent into the tank. Install the cap and shake the tank. Drain the solvent completely.

3. Pull the fuel joint assembly out of the tank.



4. Clean the filter in a suitable cleaning solvent and allow it to dry.
5. Replace the gasket with a new one. Reinstall the fuel joint assembly and tighten the screws firmly.

### 3.10 Checking and replacing anode(s)

Inspect the external anodes periodically. Remove scales from the surfaces of the anodes. Consult your dealer for replacement of external anodes.

#### **CAUTION:**

**Do not paint anodes, as this would render them ineffective and can cause more rapid engine corrosion.**



### 3.11 Checking top cowling

Check the fitting of the top cowling by pushing it with both hands. If it is loose have it repaired by your dealer.



### **3.12 Maintenance Table**

When utilized under normal condition, maintained and repaired in the proper manner, the motor can work normally within the normal life period. The normal life of the engine is 350 hours or 10 years,

whichever occurs first.

Frequency of maintenance operations may be adjusted according to the operating conditions, but the following table gives general guidelines.

The “●” symbol indicates the check-ups which you may carry out by yourself.

The “○” symbol indicates work to be carried out by your dealer.

Item	Operations	Initial		Every	
		10 hours ( 1 month )	50 hours ( 3 months )	100 hours (6 months )	200 hours ( 1 year )
Anode(s) (external)	Check/replacement		●/○	●/○	
Anode(s) (internal)	Check/replacement				○
Cooling water passages	Cleaning		●	●	
Cowling clamp	Check				●
Fuel filter (disposable)	Check/cleaning	●	●	●	
Fuel system	Check	●	●	●	
Fuel tank (portable tank)	Check/cleaning				●
Gear oil	Change	●		●	
Greasing points	Greasing			●	
Idling speed	Check/adjustment	●/○		●/○	
Propeller and cotter pin	Check/replacement		●	●	

Continuation /...1

Item	Operations	Initial	Every
------	------------	---------	-------

		10 hours ( 1 month )	50 hours ( 3 months )	100 hours ( 6 months )	200 hours ( 1 year )
Shift link/shift cable	Check/adjustment				○
Thermostat	Check				○
Throttle link/throttle cable/Throttle pick-up timing	Check/adjustment				○
Water pump	Check				○
Spark plug (s)	Cleaning/adjustment /replacement	●			●

**NOTE:**

When operating in salt water, turbid or muddy water, the engine should be flushed with clean water after every use.

## 4 Transporting and storing

### 4.1 Transporting

The outboard motor should be trailed and stored in the normal running position. If there is insufficient road clearance in this position, then trailer the outboard motor in the tilt position using a motor support device.

#### **CAUTION:**

**Do not use the tilt support lever or knob when trailing the boat. The outboard motor could shake loose from the tilt support and fall.**



#### **WARNING:**

- **Never get under the lower unit while it is tilted, even if a motor support bar is used.**

### 4.2 Storing

When store your outboard motor for prolonged periods of time (2 months or longer), several important procedures must be performed to prevent excessive damage.

It is advisable to have your outboard motor serviced by an authorized dealer prior to storage. However, you, the owner, with a minimum of tools, can perform the following procedures.

#### **CAUTION:**

**Keep the outboard motor in an upright attitude when transporting and storing it. If storing or transporting the outboard motor on its side (not upright), put it on a cushion after draining the engine oil completely.**

**Do not place the outboard motor on its side before the cooling water has drained from it completely.**

**Store the outboard motor in a dry, well-ventilated place, not in direct sunlight.**

1. Wash the outboard motor body using fresh water.
2. Disconnect the fuel line and tighten the air vent screw.
3. Remove the engine top cowling and silencer cover
4. Install the outboard motor on the test tank.
5. Fill the tank with fresh water to above the level of the anti-cavitation plate.
6. Start the engine. Flush the cooling system. Perform the flushing and fogging at the same time, as fogging/lubricating of the engine is mandatory to prevent engine rust.

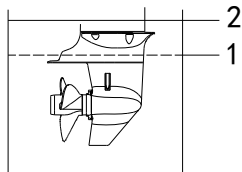

1. Lowest water level
2. Water surface

**CAUTION:**

**If the fresh water level is below the level of the anti-cavitation plate, or if the water supply is insufficient, engine seizure may occur.**



**WARNING:**

- Do not touch or remove electrical parts when starting or during the operation.
- Keep hands, hair, and clothes away from the flywheel and other rotating parts while the engine is running.

7. Run the engine at a fast idle for a few minutes in neutral position.
8. Before turning off the engine, quickly spray “Fogging Oil” into the carburetor or the fogging hole of the silencer cover, if equipped.
9. If “Fogging Oil” is not available, run the engine at a speed higher than idle until the fuel in the fuel system has run out and the engine stops. Remove the spark plug(s). Pour a teaspoonful of clean engine oil into each cylinder. Rotate the flywheel several times by hand. Replace the spark plug(s).
10. Drain the fuel from the fuel tank and drain cooling water from the engine completely. Clean the outboard motor body.

**CAUTION:**

**Store the fuel tank in a dry, well-ventilated place, not in direct sunlight.**

## **5. Actions in emergency**

### **5.1 Impact damage**

If the outboard motor hits an object in the water, follow the procedure below:

1. Stop the engine immediately.
2. Inspect the control system and all components for damage.
3. Whether damage is found or not, return to the nearest harbor slowly and carefully.
4. Have a dealer inspect the outboard motor before operating it again.

## 5.2 Power trim and tilt unit will not operate

If the engine can not be tilted up or down with the power trim and tilt because of a discharged battery or a failure with the power trim and tilt unit, the engine can not be tilted manually.

1. Loosen the manual valve screw by turning it counterclockwise until it stops.
2. Put the engine in the desired position, and then tighten the manual valve screw by turning it clockwise.



1. Manual valve screw



## 5.3 Starter will not operate

If the starter mechanism does not operate, the engine can be started with an emergency starter rope.

### **WARNING:**

- **Use this procedure only in an emergency and only to return to port for repairs.**
- **When the emergency starter rope is used to start the engine, the start-in-gear protection device does not operate. Make sure the remote control lever is in neutral.**
- **Be sure no one is standing behind you when pulling the starter rope. It could whip behind you and injure someone.**
- **Do not install the starter mechanism or top cowling after engine is running. Keep loose clothing and other objects away when starting the engine. Do not touch the flywheel or other moving parts when the engine is running.**
- **Do not touch the ignition coil, spark plug wire, spark plug cap, or other electrical components when starting or operating the motor.**

Procedure is as follows:

1. Remove the top cowling.
2. Remove the start-in-gear protection cable and the choke cable.

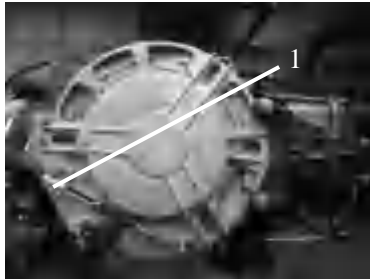

1. Start-in-gear protection cable

3. Remove the starter cover after removing the five bolts.
4. Prepare the engine for starting. For further information, see section 2.5.
5. Insert the knotted end of the emergency starter rope into the notch in the flywheel rotor and wind the rope several turns around the flywheel clockwise.
6. Pull the rope slowly until resistance is felt.
7. Give a strong pull straight out to crank and start the engine. Repeat it necessary.



## 5.5 Treatment of submerged motor

If the outboard is submerged, immediately take it to your dealer. Otherwise some corrosion may begin almost immediately.

1. Thoroughly wash away contaminants with fresh water.
2. Remove the spark plug(s), and then face the spark plug hole downward to allow any mud, or contaminants to drain.
3. Drain the fuel from the carburetor, fuel filter, and fuel line.
4. Feed engine fogging oil or engine oil through the carburetor(s) and spark plug holes while pulling the start rope to rotate the crankshaft.
5. Take the outboard motor to a PARSUN dealer as soon as possible.

### **CAUTION:**

**Do not attempt to run the outboard motor until it has been completely inspected.**

## 6. Troubleshooting

Trouble type	Possible reason	Recovery action
Starter will not operate	Starter components are faulty	Have serviced by your dealer
	Shift level is not in neutral	Shift to neutral
Engine will not start (starter operates)	Fuel tank is empty	Fill tank with clean, fresh fuel
	Fuel is contaminated or stale	Fill tank with clean, fresh fuel
	Fuel filter clogged	Clean or replace with recommended type
	Fuel pump has malfunctioned	Have serviced by your dealer
	Spark plug(s) fouled or of incorrect type.	Inspect spark plug(s). Clean or replace with recommended type
	Spark plug cap(s) fitted incorrectly	Check and re-fit cap(s)
	Ignition wiring damaged or poorly connected	Check wires for wear or breaks. Tighten all loose connections. Replace worn or broken wires
	Ignition parts are faulty	Have serviced by your dealer
	Engine stop switch lanyard is not attached	Attach lanyard
	Engine inner parts are damaged	Have serviced by your dealer
Engine idles irregularly or stalls	Spark plug(s) fouled or of incorrect type.	Inspect spark plug(s). Clean or replace with recommended type

<b>Trouble type</b>	<b>Possible reason</b>	<b>Recovery action</b>
Engine idles irregularly or stalls	Fuel system is obstructed	Check for pinched or kinked fuel line or other obstructions in fuel system
	Fuel is contaminated or stale	Fill tank with clean, fresh fuel
	Fuel filter clogged	Clean or replace with recommended type
	Spark plug gap is incorrect	Inspect and adjust as specified
	Ignition wiring damaged or poorly connected	Check wires for wear or breaks. Tighten all loose connections. Replace worn or broken wires
	Specified engine oil is not being used	Check and replace oil as specified
	Thermostat is faulty or clogged	Have serviced by your dealer
	Carburetor adjustments are incorrect	Have serviced by your dealer
	Carburetor is clogged	Have serviced by your dealer
	Fuel pump is damaged	Have serviced by your dealer
	Air vent screw on fuel tank is closed	Open air vent screw
	Fuel joint connection is incorrect	Connect correctly
	Throttle valve adjustment is incorrect	Have serviced by your dealer
	Choke handle is pulled out	Return to home position
Motor angle is too high	Return to normal operating position	

<b>Trouble type</b>	<b>Possible reason</b>	<b>Recovery action</b>
Engine power loss	Propeller is damaged	Repair or replace propeller
	Trim angle is incorrect	Adjust trim angle to achieve most efficient operation
	Motor is mounted at incorrect transom height	Adjust motor to proper transom height
	Boat bottom is fouled with marine growth	Clean boat bottom
	Weeds or other foreign matter are tangled on gear housing	Remove foreign matter and clean lower unit
	Spark plug(s) are fouled or incorrect type	Inspect spark plug(s). Clean or replace with recommended type
	Fuel system is obstructed	Check for pinched or kinked fuel line or other obstructions in fuel system
	Fuel filter is clogged	Clean or replace with recommended type
	Fuel is contaminated or stale	Fill tank with clean, fresh fuel
	Spark plug gap is incorrect	Inspect and adjust as specified
	Ignition wiring is damaged or poorly connected	Check wires for wear or breaks. Tighten all loose connections. Replace worn or broken wires
	Ignition parts have failed	Have serviced by your dealer
Specified engine oil is not being used	Check and replace oil as specified	

## Continuation /...3

<b>Trouble type</b>	<b>Possible reason</b>	<b>Recovery action</b>
Engine power loss	Thermostat is faulty or clogged	Have serviced by your dealer
	Air vent screw on fuel tank is closed	Open air vent screw
	Fuel pump has malfunctioned	Have serviced by your dealer
	Fuel joint connection is incorrect	Connect correctly
Engine vibrates excessively	Specified spark plug(s) are not being used	Check and replace spark plug(s) as specified
	Propeller is damaged	Repair or replace propeller
	Propeller shaft is damaged	Have serviced by your dealer
	Weeds or other foreign matter are tangled on propeller	Remove and clean propeller
	Motor mounting bolt is loose	Tighten bolt
	Steering pivot is loose	Tighten it
Steering pivot is damaged	Have serviced by your dealer	

## 7. Circuit diagram

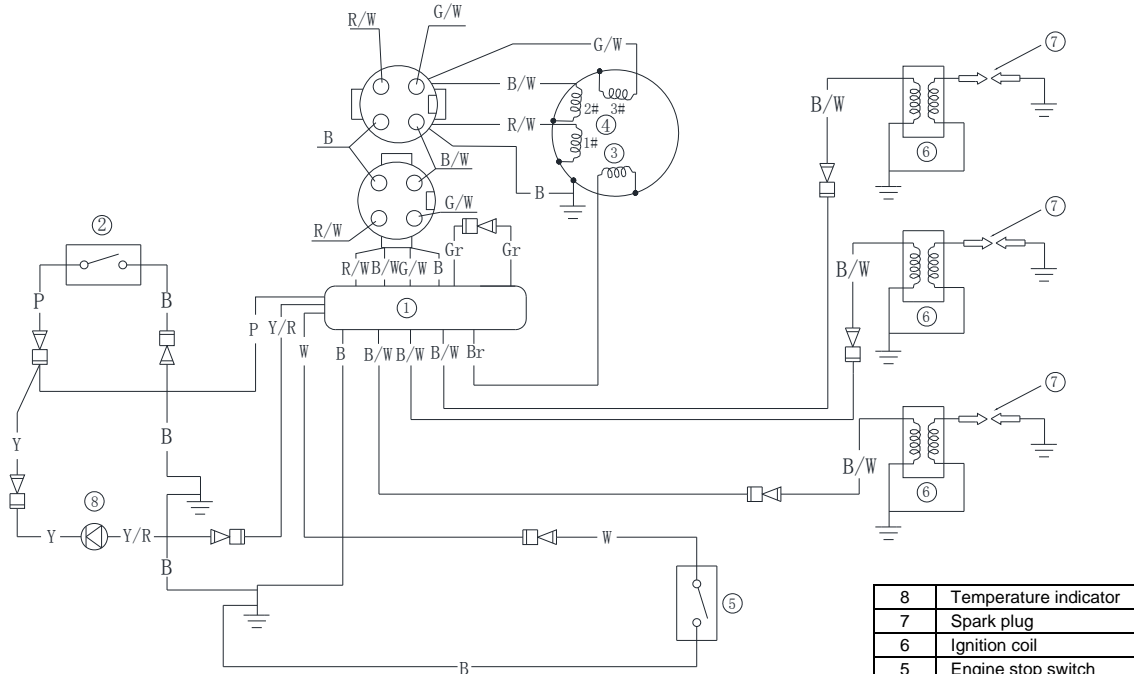

T50BM

<b>G/W</b>	Green/White	<b>B/W</b>	Black/White
<b>P</b>	Pink	<b>R/W</b>	Red/White
<b>Br</b>	Brown	<b>B</b>	Black
<b>Y/R</b>	Yellow/Red	<b>W</b>	White
<b>Y</b>	Yellow	<b>Gr</b>	Grey

<b>8</b>	Temperature indicator
<b>7</b>	Spark plug
<b>6</b>	Ignition coil
<b>5</b>	Engine stop switch
<b>4</b>	Pulsed coil
<b>3</b>	Charge coil
<b>2</b>	Temperature switch
<b>1</b>	C.D.I. UNIT
<b>S.N.</b>	PART NAME



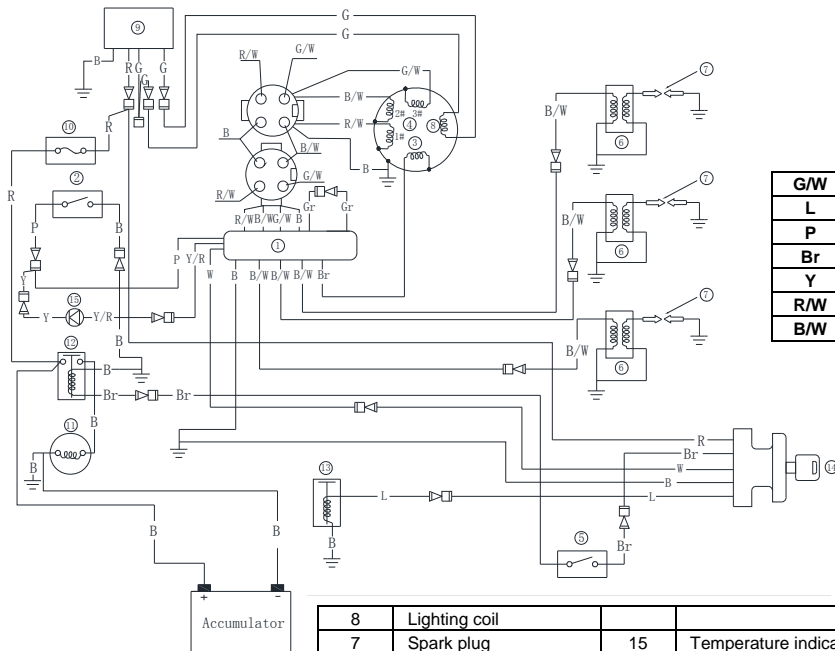

T50/60BW

<b>G/W</b>	Green/White	<b>R</b>	Red
<b>L</b>	Blue	<b>B</b>	Black
<b>P</b>	Pink	<b>W</b>	White
<b>Br</b>	Brown	<b>Gr</b>	Grey
<b>Y</b>	Yellow	<b>G</b>	Green
<b>R/W</b>	Red/White	<b>Y/R</b>	Yellow/Red
<b>B/W</b>	Black/White		

**Starter switch conditions**

	W	B	R	Br	L
OFF	—				
ON					
START			—		

8	Lighting coil		
7	Spark plug	15	Temperature indicator
6	Ignition coil	14	Starter switch
5	Neutral switch	13	Choke solenoid
4	Pulsed coil	12	Starter relay
3	Charge coil	11	Starter motor
2	Temperature switch	10	Fuse
1	C.D.I. UNIT	9	Rectifier
S.N.	PART NAME	S.N.	PART NAME

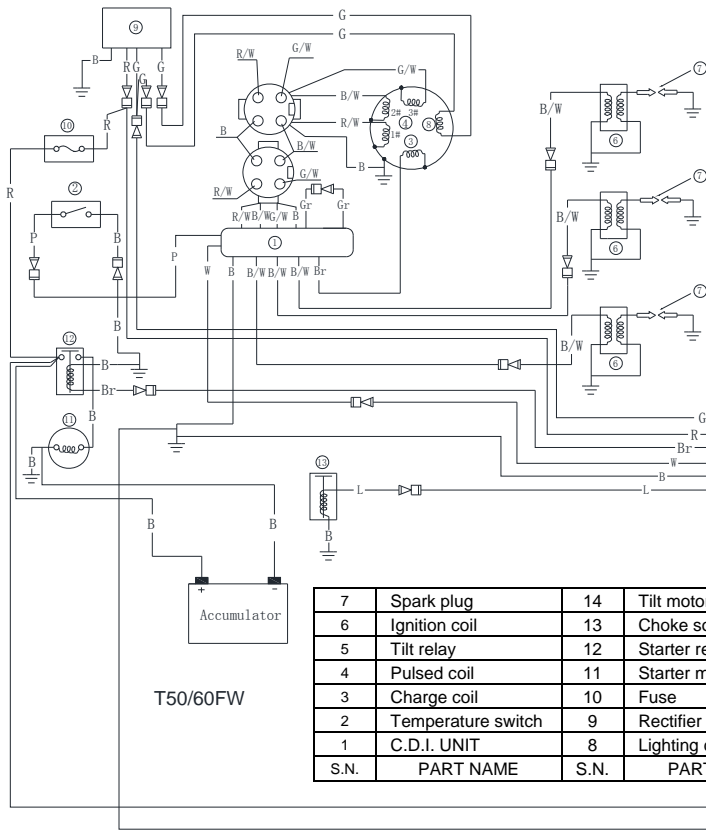

<b>G/W</b>	Green/White	<b>B</b>	Black
<b>L</b>	Blue	<b>W</b>	White
<b>P</b>	Pink	<b>Gr</b>	Grey
<b>Br</b>	Brown	<b>G</b>	Green
<b>R/W</b>	Red/White	<b>Sb</b>	Lavender
<b>B/W</b>	Black/White	<b>Lg</b>	Green tint
<b>R</b>	Red		

T50/60FW

7	Spark plug	14	Tilt motor
6	Ignition coil	13	Choke solenoid
5	Tilt relay	12	Starter relay
4	Pulsed coil	11	Starter motor
3	Charge coil	10	Fuse
2	Temperature switch	9	Rectifier
1	C.D.I. UNIT	8	Lighting coil
S.N.	PART NAME	S.N.	PART NAME

